

METRIC MACHINE SCREW ACTUATORS 150 kN CAPACITY

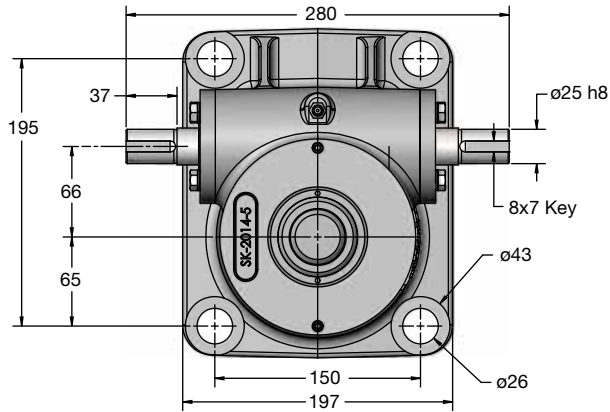

Top View: G9015T

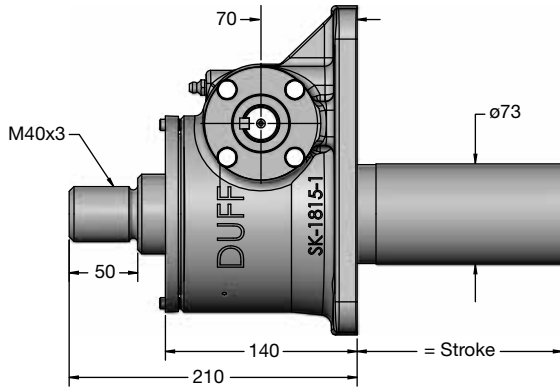

Upright: G9015T

58mm O.D. x 12mm Lead Lifting Screws

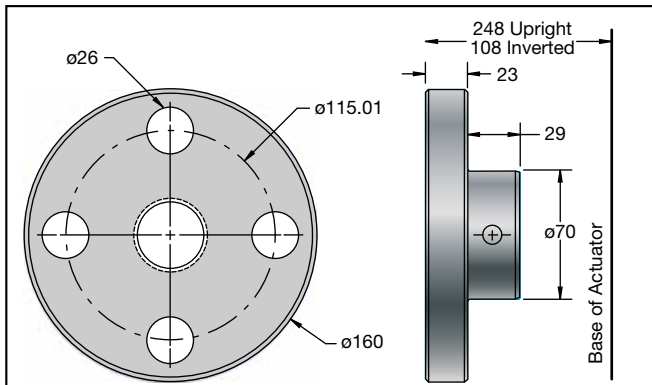

Top Plate G9015-6

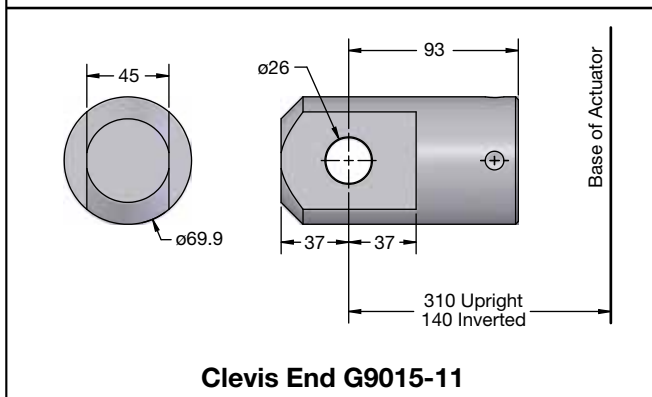

Clevis End G9015-11

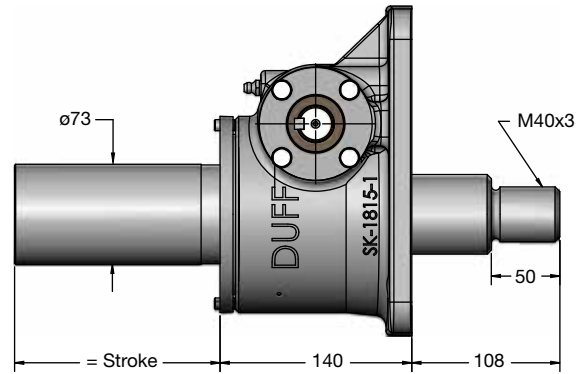

Inverted: G9015TV

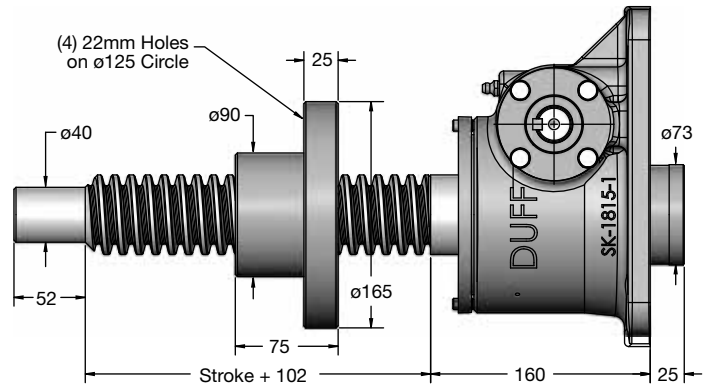

Upright Rotating: G9015U

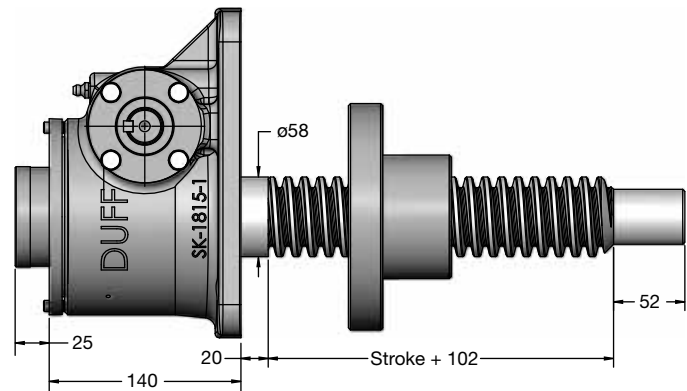

Inverted Rotating: G9015D